











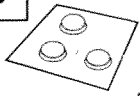

INSTALLATION  
INSTRUCTIONS

PART NUMBER: E231SAJ000

DESCRIPTION: HOOD DEFLECTOR

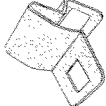
VEHICLE DESCRIPTION: SUBARU LEGACY/OUTBACK

<b>A</b>	 1x		<b>B</b>	 2x	<b>C</b>	 6x	<b>D</b>	 3x
<b>E</b>	 2x	<b>F</b>  2x	<b>G</b>  6x	<b>H</b>  6x	<b>I</b>  6x	<b>J</b>	 4x	
<b>K</b>	 2x	<b>L</b>  9x	<b>M</b>  2x					

**Tools Required**

Phillips head screwdriver

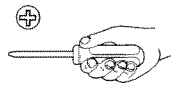

**Meaning of Characters:**



:Remove



:Install



:Disconnect

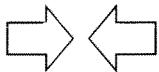

:Connect



:Location of Clips or Screws

T

:Tightening Torque



:Loosen

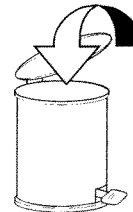

:Discard

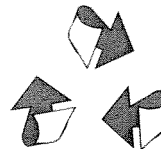

:Re - use

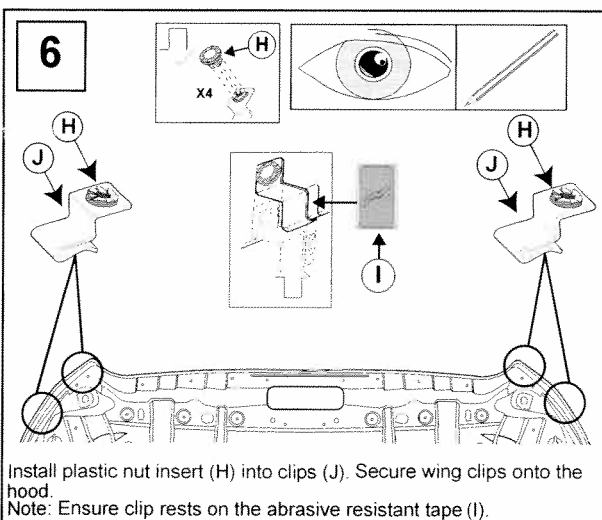
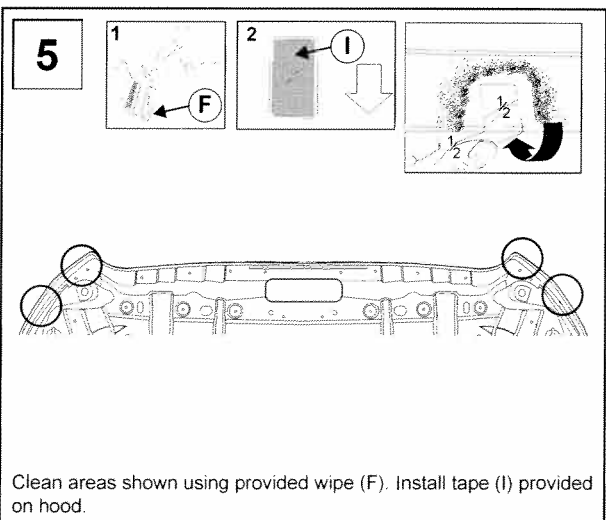
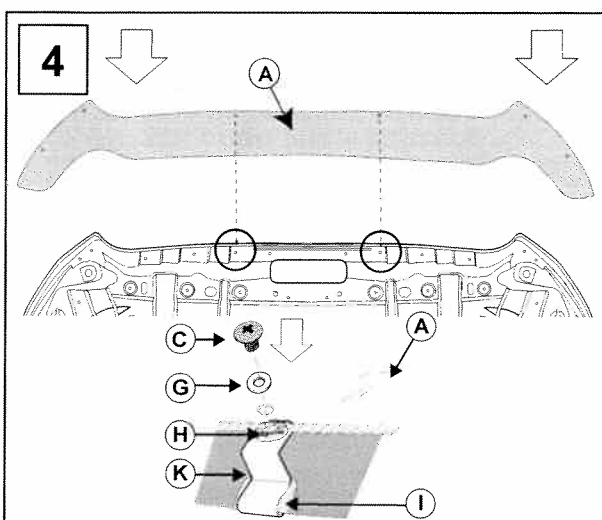
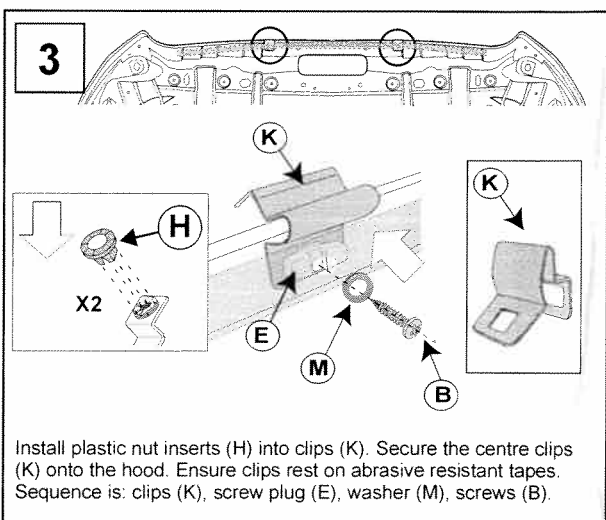
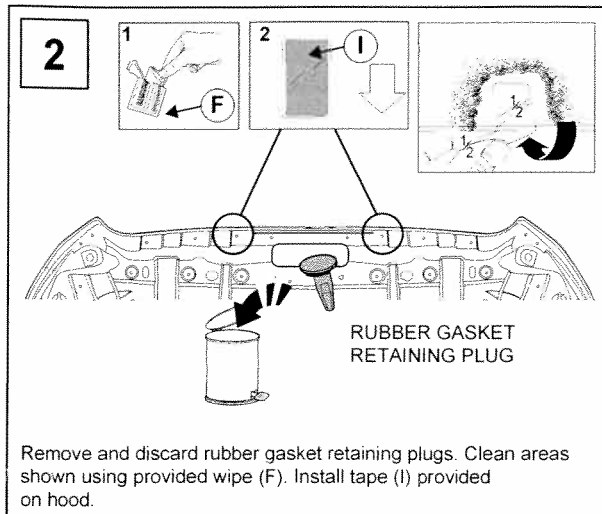
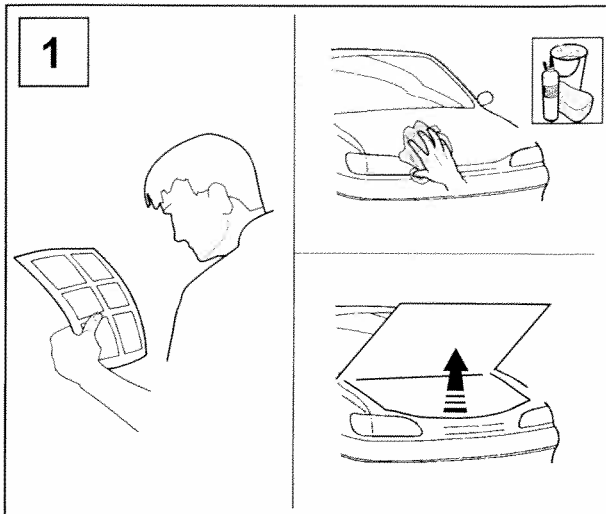

**7**

Using washers (G) and screws (C) provided, secure the outer wing clips (J) first followed by the inner wing clips (I).

**8**

Find all bumpon (D) locations contacting hood.

**9**

Clean hood adjacent to bumpons (D) using wipe (F).

**10**

Install tape (L) at all bumpon (D) locations directly onto hood.

**11**

DO NOT USE solvent based cleaners on Hood Deflector.  
USE soap and water only to clean Hood Deflector.

DO NOT SLAM HOOD.

- PLACE INSTRUCTIONS IN GLOVE BOX.
- PERIODICALLY CHECK BUMPONS AND TAPE.











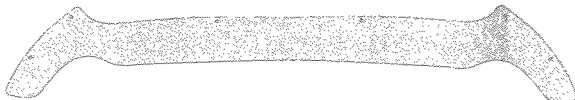

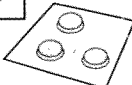

NO DE PIÈCE: E231SAJ000

DESCRIPTION: HOOD DEFLECTOR

DIRECTIVES  
D'INSTALLATION

DESCRIPTION DU VÉHICULE : SUBARU LEGACY/OUTBACK

<b>A</b>  1x	<b>B</b>  2x	<b>C</b>  6x	<b>D</b>  3x		
<b>E</b>  2x	<b>F</b>  2x	<b>G</b>  6x	<b>H</b>  6x	<b>I</b>  6x	<b>J</b>  4x
<b>K</b>  2x	<b>L</b>  9 x	<b>M</b>  2x			

**Outils nécessaires**

Tournevis à tête Philips étoilée

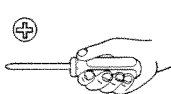



~~~~  
AUCUN OUTIL ÉLECTRIQUE

**Signification des symboles:**

 : Déposer

 : Poser

 : Déconnecter

 : Connecter

 : Emplacement d'agrafes ou de vis

**T** : Couple de serrage

 : Desserrer

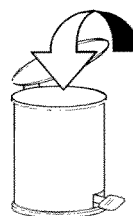
 : Jeter

 : Réutiliser

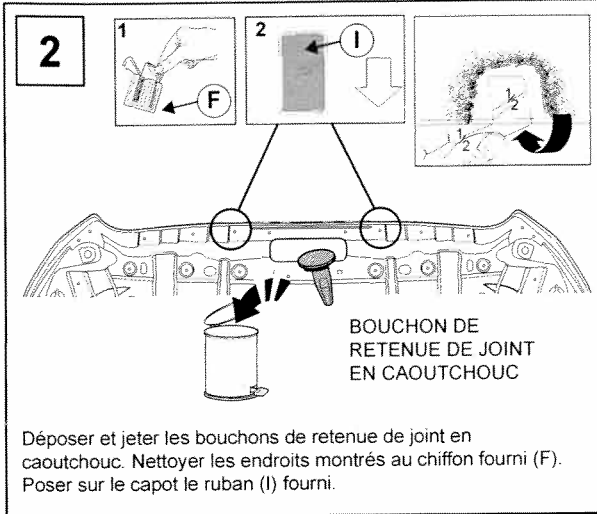
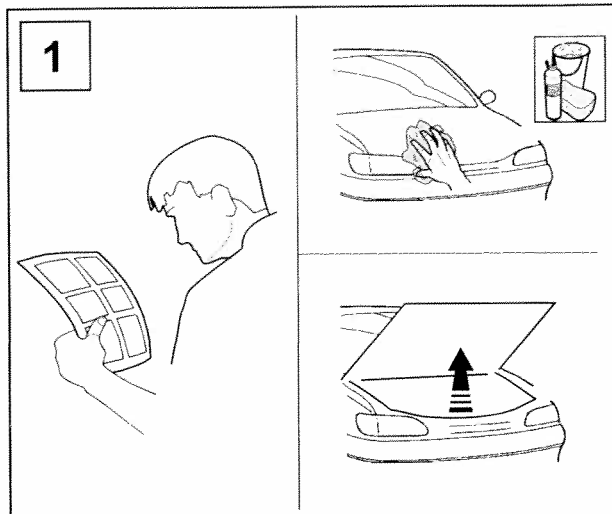

Déposer et jeter les bouchons de retenue de joint en caoutchouc. Nettoyer les endroits montrés au chiffon fourni (F). Poser sur le capot le ruban (I) fourni.

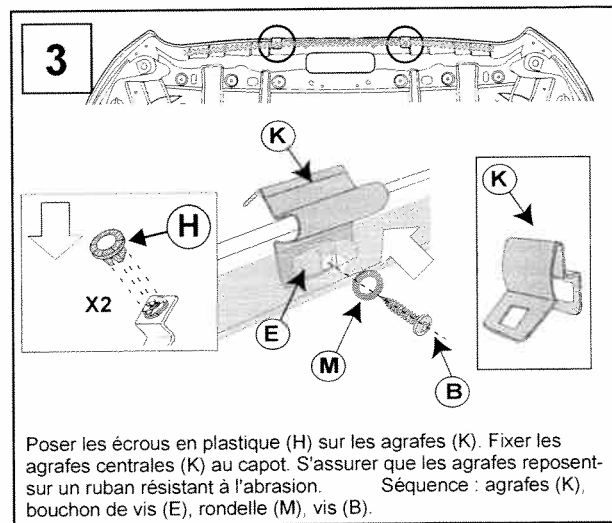

Poser les écrous en plastique (H) sur les agrafes (K). Fixer les agrafes centrales (K) au capot. S'assurer que les agrafes reposent sur un ruban résistant à l'abrasion. Séquence : agrafes (K), bouchon de vis (E), rondelle (M), vis (B).

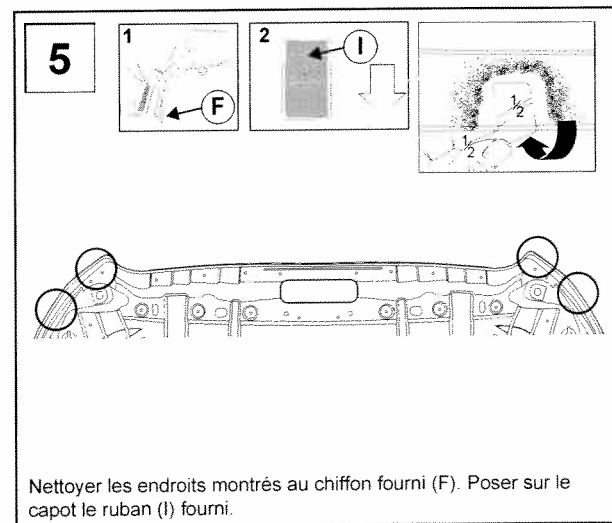
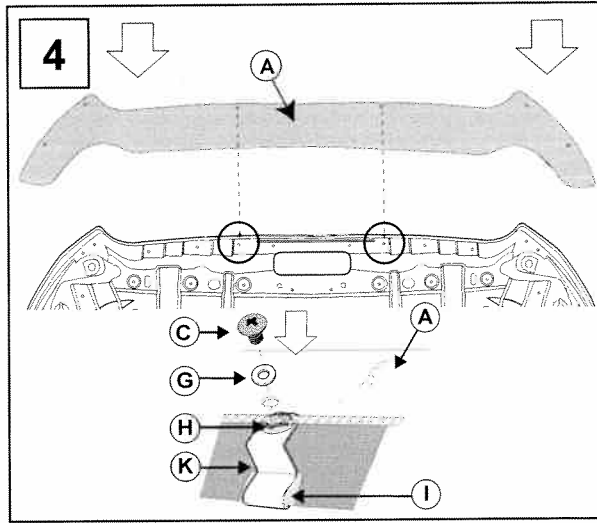

Nettoyer les endroits montrés au chiffon fourni (F). Poser sur le capot le ruban (I) fourni.

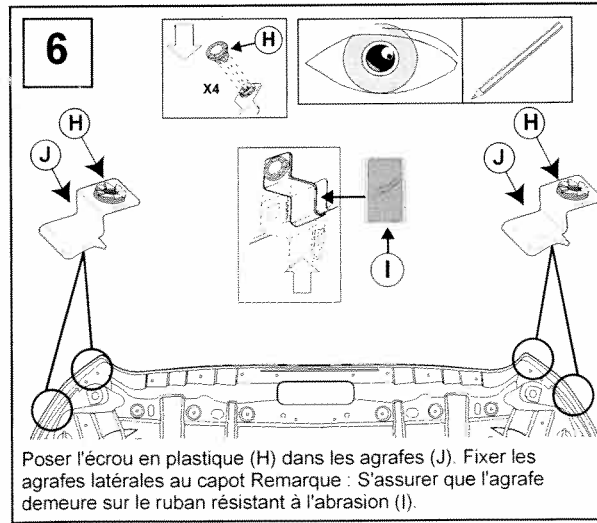

Poser l'écrou en plastique (H) dans les agrafes (J). Fixer les agrafes latérales au capot. Remarque : S'assurer que l'agrafe demeure sur le ruban résistant à l'abrasion (I).

**7**

Au moyen des rondelles (G) et des vis (C) fournies, fixer les agrafes latérales extérieures (J) en premier, puis les agrafes latérales intérieures

**8**

Trouver tous les endroits de buppon (D) en contact avec le capot.

**9**

Nettoyer l'endroit de capot adjacent aux bumpers (D) au moyen du chiffon (F).

**10**

Poser le ruban (L) à tous les bumpers (D) directement sur le capot.

**11**

NE PAS UTILISER de nettoyeurs à base de solvant sur le déflecteur de capot.  
UTILISER seulement savon et eau pour nettoyer le déflecteur

NE PAS CLAQUER LE CAPOT

- METTRE LES INSTRUCTIONS DANS LE COFFRE À GANTS.
- VÉRIFIER LES BUMPON ET LE RUBAN DE FAÇON PÉRIODIQUE.