

OUTLANDER CIGARETTE LIGHTER KIT MZ360133EX INSTALLATION AND HANDLING INSTRUCTIONS

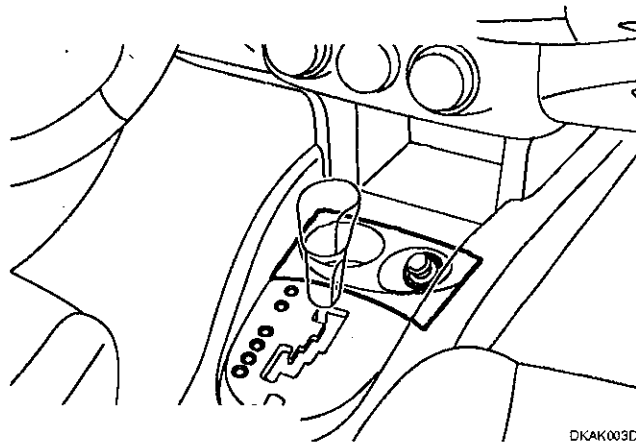

Thank you for purchasing the Mitsubishi Genuine Accessory.
To install and use the product correctly with proper knowledge of it, read this publication carefully.
Keep this publication for reference when maintenance is required.

Attention

- This publication gives precautionary instructions in the boxes titled as follows.
Read through these instructions thoroughly.

⚠ Caution Describes precautions that should be observed in order to prevent injury or damage to the vehicle or its components, which may occur if sufficient care is not taken.

- Failure to follow these instructions not only prevents the product from working properly but may lead to trouble with the vehicle. Be sure to follow all instructions carefully.
- If there is anything unclear about the installation, handling and/or usage of the product, contact your Mitsubishi Motors dealer for clarification.
- Mitsubishi Motors Corporation is not responsible for any defects or difficulties caused by or resulting from the failure to follow given instructions.
- We recommend you to have the installation performed at an authorized Mitsubishi Motors dealer.

To the dealer:
Be sure that the customer receives this publication.

■ **TOOLS** (Make the following tools ready for use.)

Trim remover



Multimeter

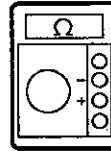

■ **COMPONENTS** (Make sure that all of the following components were included in the kit.)

- ① Cigarette lighter: 1
- ② Cigarette lighter case: 1
- ③ Cigarette lighter nut: 1

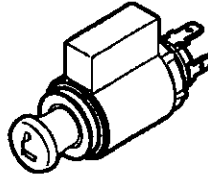

■ **PRECAUTIONS**

- Be sure to apply the parking brake securely. Remove the ignition key from the key cylinder.
- Disconnecting the (-) cable from the battery causes the radio and audio presets, the clock, etc. to lose their memory. Record the contents of the memory before disconnecting the battery negative cable so that you can reprogram the radio presets after completing the installation.
- Be careful not to damage the vehicle during installation.
- Connect wiring harnesses securely.
- To prevent damage to harnesses, be sure to fasten them all with vinyl tape or tie wraps where they may otherwise dangle and touch vehicle parts.

Before installation

- Be sure to disconnect the negative terminal cable from the battery.

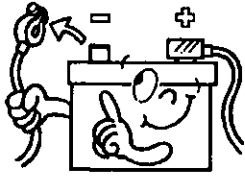

When installing or removing parts

- Loosen or tighten bolts and nuts using tools that match their sizes.

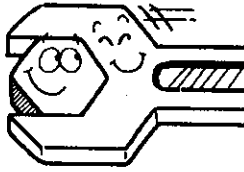

- Use a Phillips screwdriver that fits the recess in the head of the screw being loosened or tightened.



- To remove plastic parts, use a trim remover.

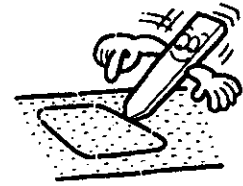

Wiring

- When disconnecting connectors, first unlock them, then separate the connectors by pulling on themselves, not on cables.

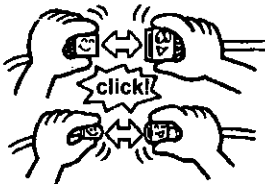

- When connecting connectors, push them against each other until the lock clicks.

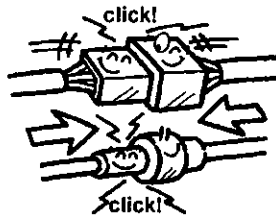

- Do not pull on wiring harnesses strongly.

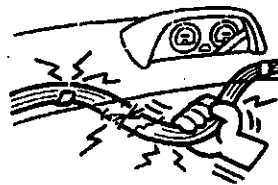

- Do not let harnesses be pinched between parts.

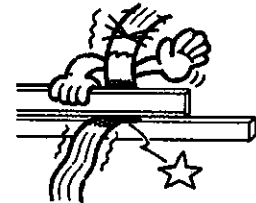

- Route the harness away from hot components such as the engine and radiator.

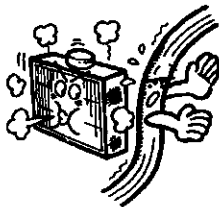

- Protect the harness from sharp edges by covering the edges with tape or other suitable materials.

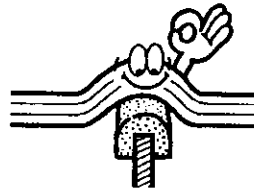

- Apply sealant to grommets at portions where the harness run through.

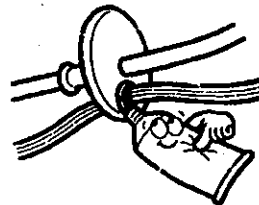

- Do not fasten the harness to brake pipes or high pressure air conditioner pipes.

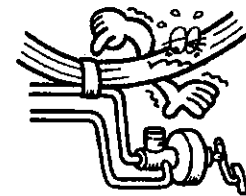

Clamping harness

- Fasten the additional harness to an existing vehicle harness using tape or tie wraps.

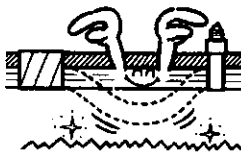

- Bind up extra length of the harness using a tie wrap.



- If one tie wrap is too short, use two connected together.



After installation

- Check the product and wiring for installed condition before connecting the cable to the battery.

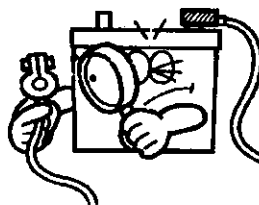

- Check the installed product for function. Also check lamps, horn, wipers, etc. for proper operation.

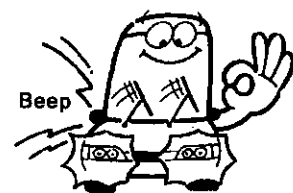

INSTALLATION PROCEDURES

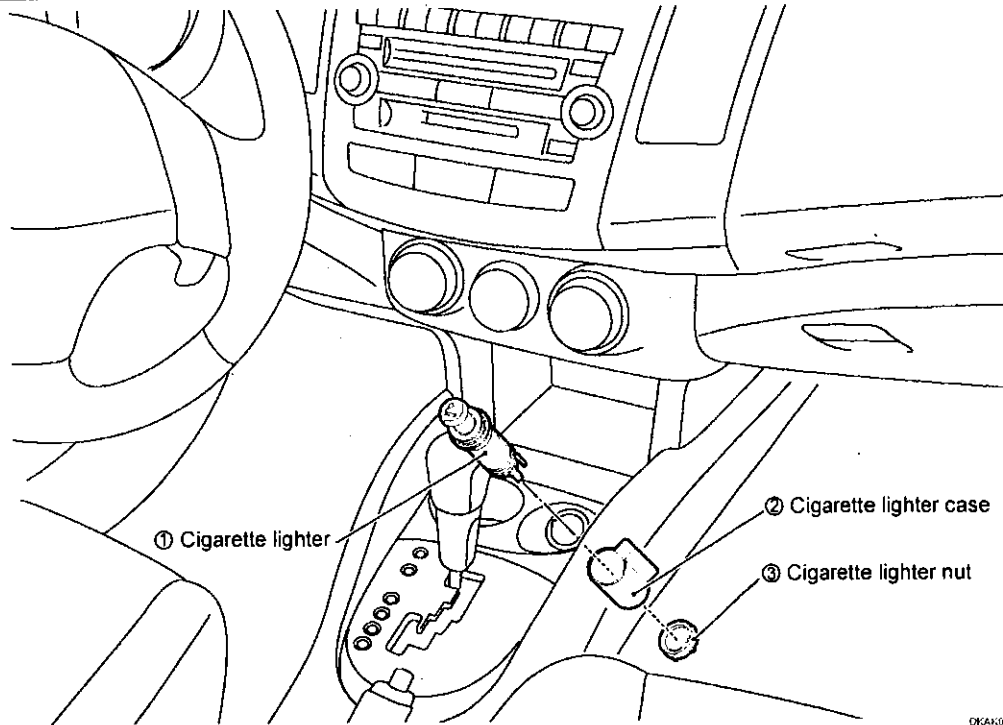

A. REMOVING THE CENTER CONSOLE UPPER PANEL ASSEMBLY

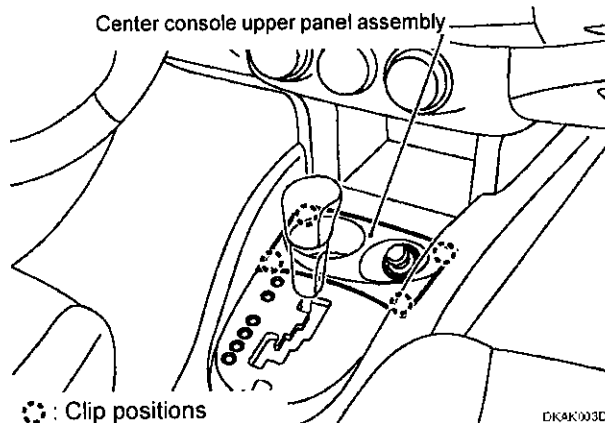

- 1) Check that the ignition switch and light switch are off, then disconnect the battery (-) cable.
- 2) Remove the center console upper panel assembly by releasing the four clips.

Check

B. REMOVING THE ACCESSORY SOCKET

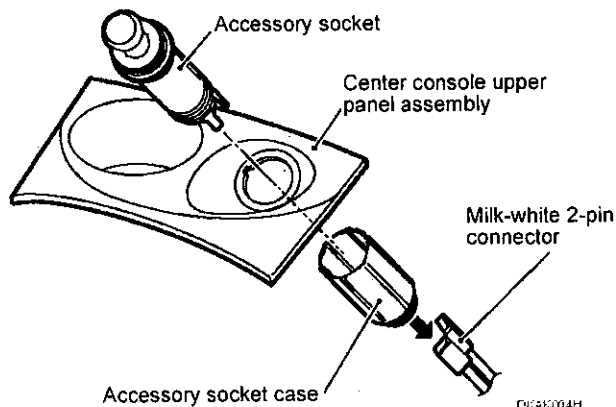

- 1) Disconnect the milk-white 2-pin connector from the accessory socket.
- 2) Turn and remove the accessory socket case from the accessory socket.
- 3) Remove the accessory socket from the center console upper panel assembly.

Check

C. INSTALLING THE CIGARETTE LIGHTER

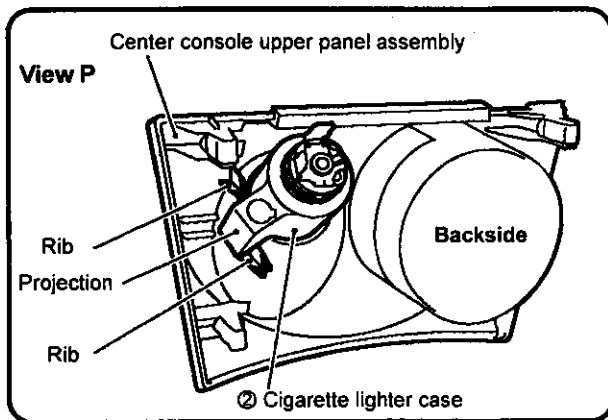
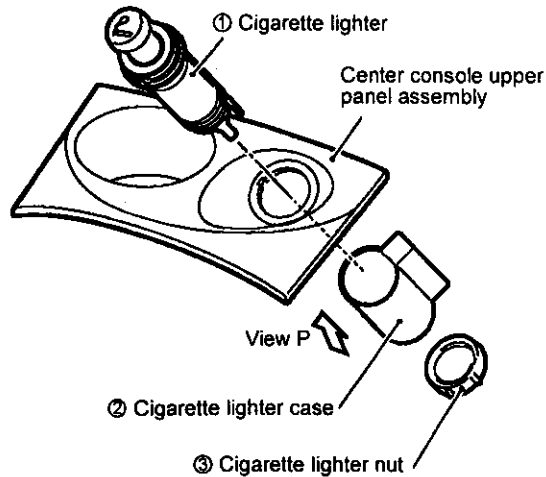

DKAK005H

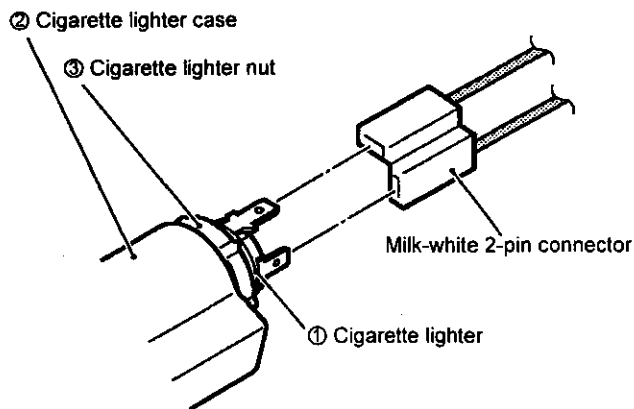

DKAK006H

- 1) Insert the cigarette lighter ① into the center console upper panel assembly where the accessory socket has been mounted.
- 2) As shown in View P, install the cigarette lighter case ② over the cigarette lighter ① with its projection located between the ribs at the back of the center console upper panel assembly.
- 3) Tighten the cigarette lighter nut ③ to secure the cigarette lighter ① and the cigarette lighter case ② in position.

Tightening torque: 100 N or higher

- 4) Connect the milk-white 2-pin connector to the cigarette lighter ①.

⚠ Caution

Be sure to route the harness so as not to interfere with the edges or the moving parts.

Check

D. OPERATION CHECK

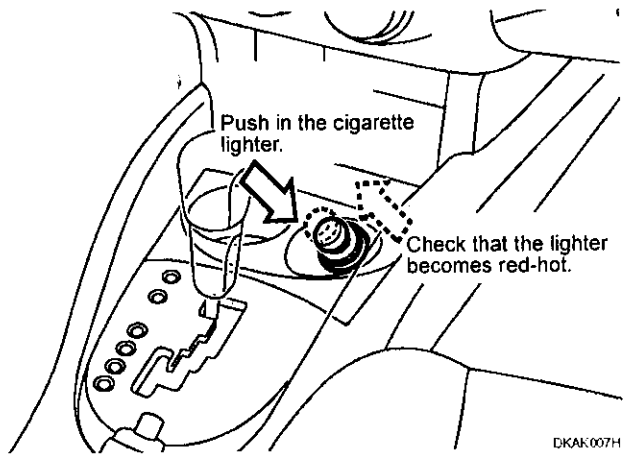

Perform the following operation check.

Caution

Do not touch the cigarette lighter for a few minutes after checking the operation as it is still hot.

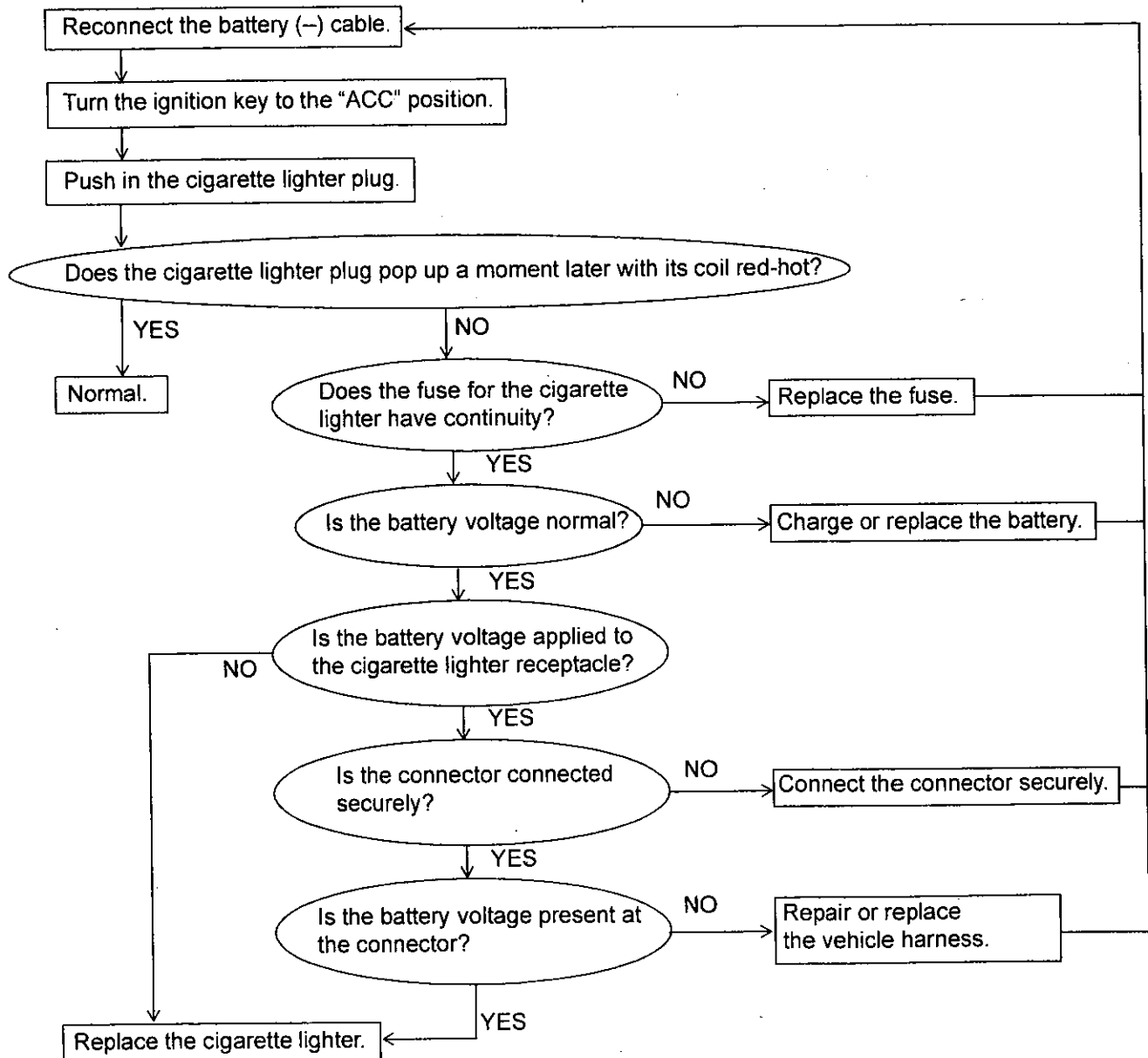

Check

E. REINSTALLING THE CENTER CONSOLE UPPER PANEL ASSEMBLY

- 1) Check that the cigarette lighter nut is tightened firmly and the 2-pin connector is connected securely.
- 2) Reinstall the center console upper panel assembly with the cigarette lighter while taking care not to trap or cause tension to the lighter harness.

Check

F. CHECKING AFTER INSTALLATION

- Check that the door lock, power windows, hazard warning lamps and other electrical systems operate correctly.
- Reprogram the radio and audio memories and adjust the clock. For the reprogramming procedure, refer to the owner's manual.

Check

G. WIRING DIAGRAM

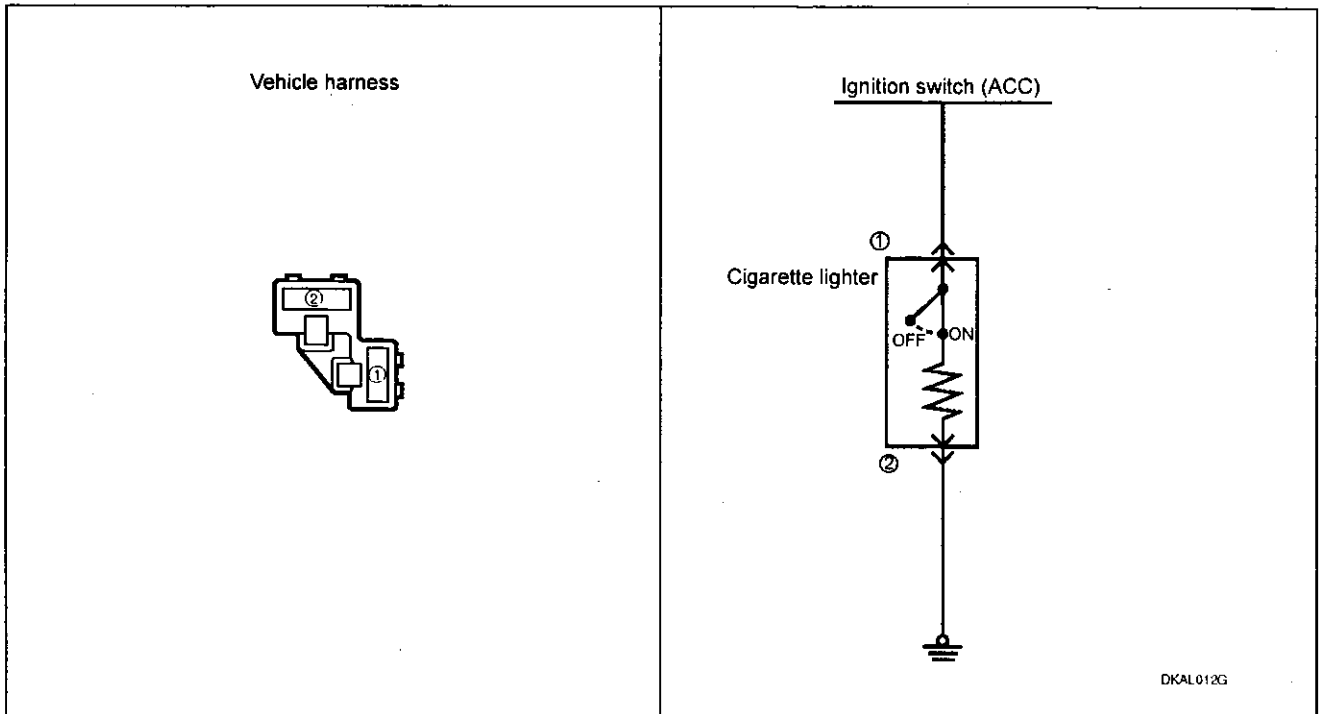

Check