



# INSTALLATION INSTRUCTIONS

Accessory  
**ROOF BOX**  
P/N 08L02-TA1-200

Application  
**2013 RDX**

Publications No.  
**BII 13458**  
Issue Date  
**MARCH 2012**

## PARTS LIST

Roof box

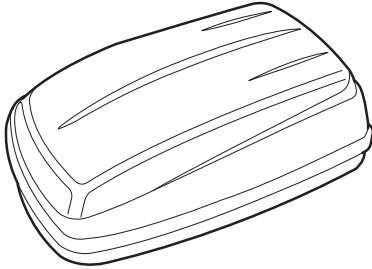

4 Brackets A

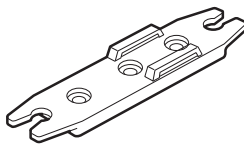

4 Brackets B

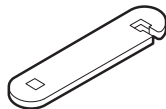

4 Plates



8 Knobs



8 Bolts



8 Washers



2 Straps



Seal

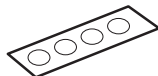

2 Keys



4 Large pads

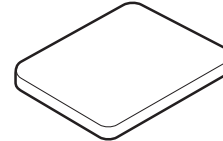

4 Small pads

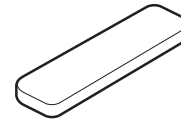

## TOOLS AND SUPPLIES REQUIRED

Isopropyl alcohol  
Shop towel

## INSTALLATION

### NOTE:

- Be careful not to damage the roof and other finished surfaces of the body when installing the roof box.
- An Acura roof rack, sold separately, is required to install the roof box.
- The maximum load capacity for roof racks vary from model to model. Check the vehicle owner's manual, the roof rack installation instructions, or the load label on the rack for the roof rack load capacity.
- The maximum load capacity for the roof box is 110 lb (50 kg); approximate roof box weight is 29 lb (13 kg).
- Do not allow the combined weight of the roof box and cargo to exceed the carrying capacity of the roof rack.

1. With the help of an assistant, carefully place the box on the crossbars. Open the tailgate to make sure that the box is not interfering with the tailgate.

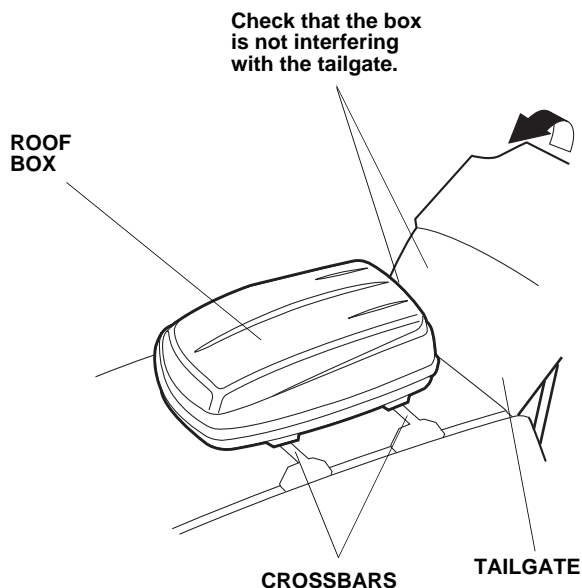

2. Open the roof box, and align the holes in the plate with the mounting location at the forward crossbar. The plate is located at the front of the base of the roof box.

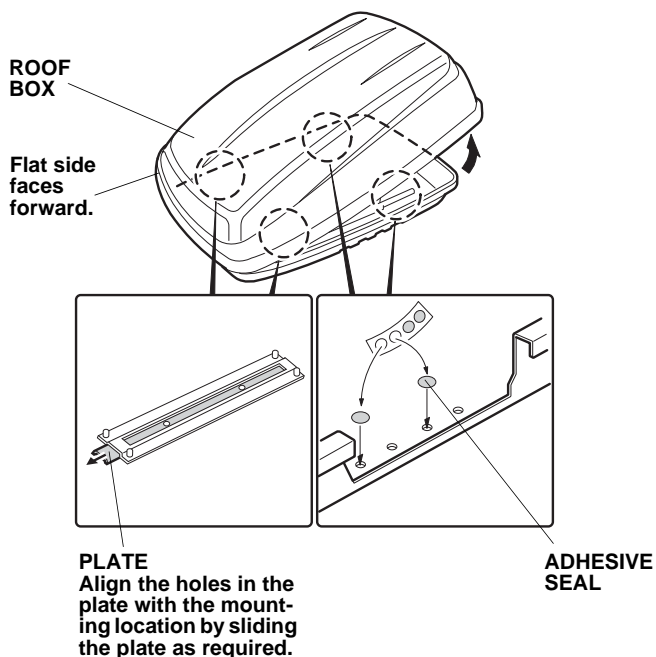

3. Attach an adhesive seal over each of the four unused mounting holes (two on each side) at the rear of the base of the box. The seals will help prevent water from entering the roof box. Then, remove the roof box from the crossbars.

4. Using isopropyl alcohol on a shop towel, clean four brackets B where the small pads will attach. Remove the adhesive backings from the small pads, and attach them to the brackets B.

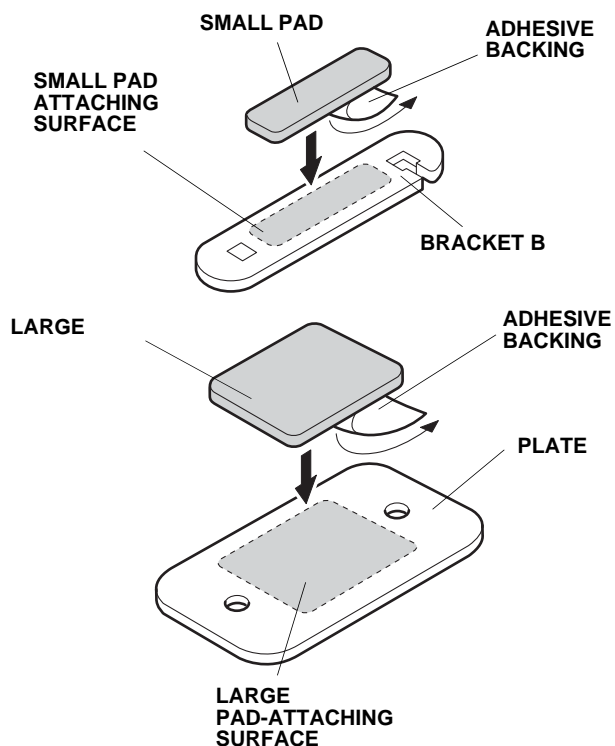

5. Using isopropyl alcohol on a shop towel, clean the four plates where the large pads will attach. Remove the adhesive backings from the large pads, and attach them to the plates.

- Under the roof box, insert a bolt through bracket B, through the plate, and into the predrilled hole in the bottom of the roof box. Install bracket B and the plate with the pads facing each other.

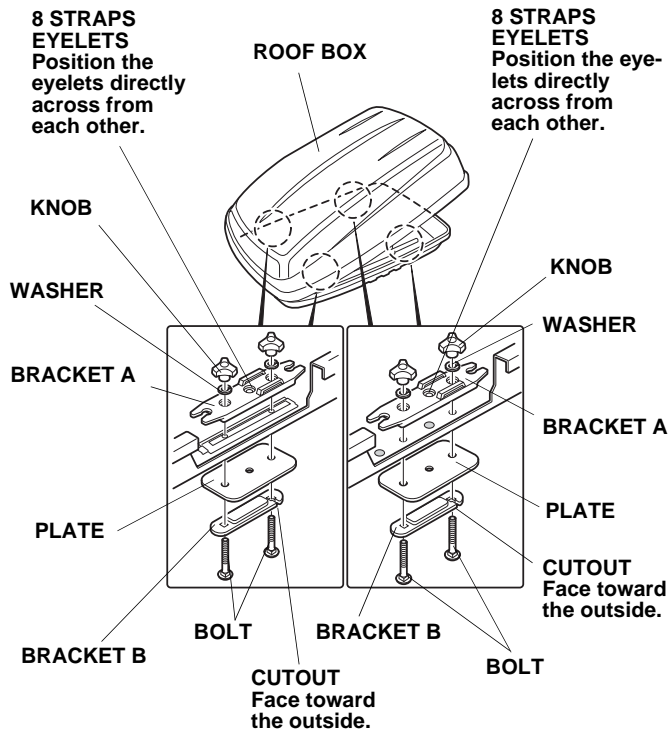

- Fit bracket A over the threads of the bolt where it extends through the roof box. Install a washer over the threads, and loosely install a knob. Install a second bolt the same way.
  - Install each bracket A so that the right and left eyelet holes are positioned across from each other.
  - Install bracket B with the cutout facing the outside.

- With the help of an assistant, carefully place the box back on the crossbars. Be aware of the hardware hanging from the bottom of the box.

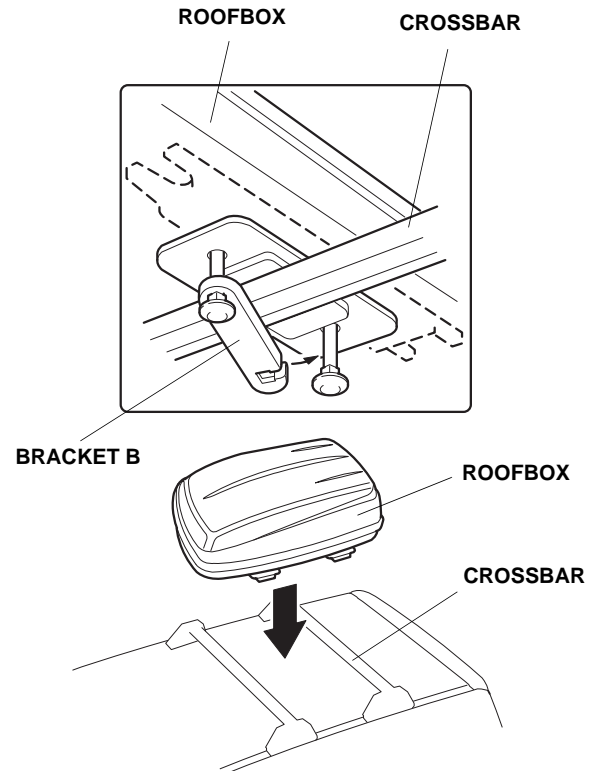

- Arrange each plate to fit between the box and the crossbar. Swing the slotted end of bracket B around the bolt, and tighten the knobs. Fasten the box this way at all four mounting points.
  - If necessary, adjust the distance between the crossbars to match the pattern of the predrilled holes in the roof box. The bar spread required is 800 mm (31 in.) for all racks.
  - The roof box should be centered on the crossbars and parallel to the direction of travel with its flat side facing the front.

10. Insert the straps through the eyelets on bracket A, and attach the ends of the straps together.

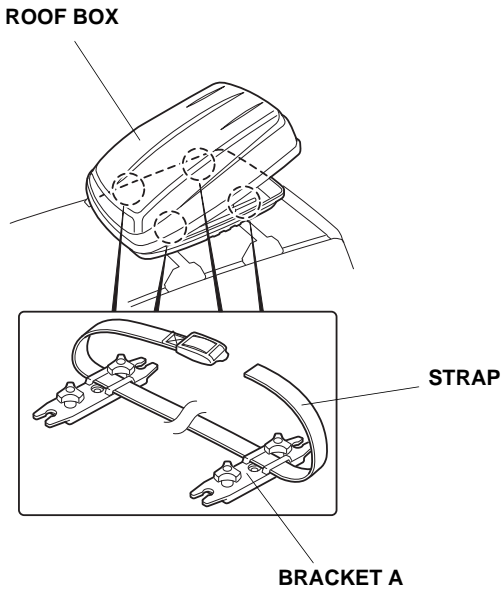

## LOADING THE ROOF BOX

Load weight equally on both sides to minimize imbalance. Do not overload the roof box; the maximum allowable load is 110 lb (50 kg).

Loads must be secured to prevent them from sliding. Check the fasteners at regular intervals.

## USE AND CARE

### Unlocking/Locking the Roof Box

**Unlocking:** Insert the key into the lock, and turn it counterclockwise to unlock. Press the center button to lift the lid of the roof box.

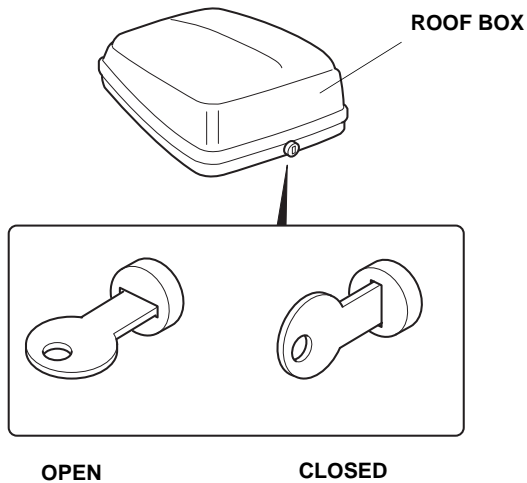

**Locking:** Press down on the lid. There should be an audible click. Be sure the lid is latched by attempting to lift the lid. Turn the key clockwise to lock the roof box. Remove the key while not in use. Be sure the straps do not dangle from the box.